

LEG MEASUREMENTS

BENCHES & OTTOMANS

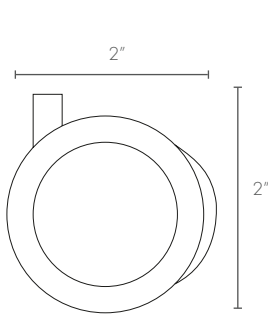

Caster Wheel*

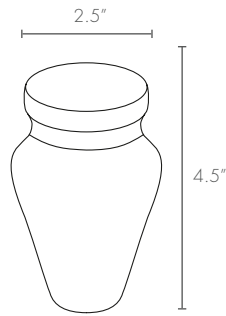

Chest*

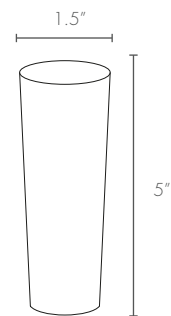

Wood Round*

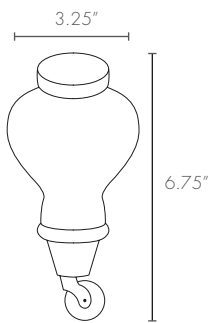

Wood Caster*

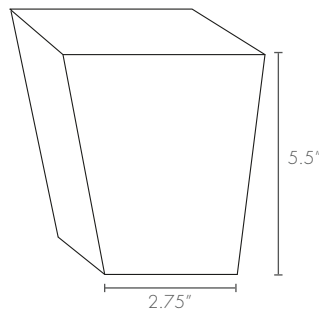

Wood Cube*

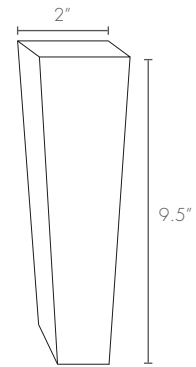

Wood Square*

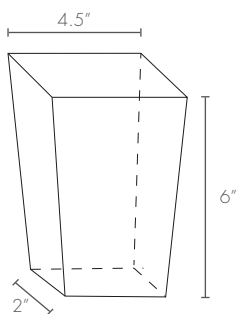

Lucite Taper*

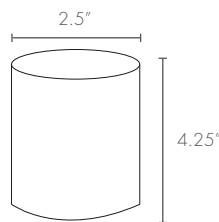

Lucite Round*

* Felt-padded glides may add approximately .25" to leg height

EASTERN ♦ ACCENTS®
UPHOLSTERY WORKSHOP